



DSK32 THRU DSK320

Reverse Voltage - 20 to 200 Volts Forward Current - 3.0 Ampere

SURFACE MOUNT SCHOTTKY BARRIER RECTIFIER

Features

- ◆ The plastic package carries Underwriters Laboratory Flammability Classification 94V-0
- ◆ For surface mounted applications
- ◆ Metal silicon junction, majority carrier conduction
- ◆ Low power loss, high efficiency
- ◆ Built-in strain relief, ideal for automated placement
- ◆ High forward surge current capability
- ◆ High temperature soldering guaranteed:
250 °C/10 seconds at terminals

SOD-123FL

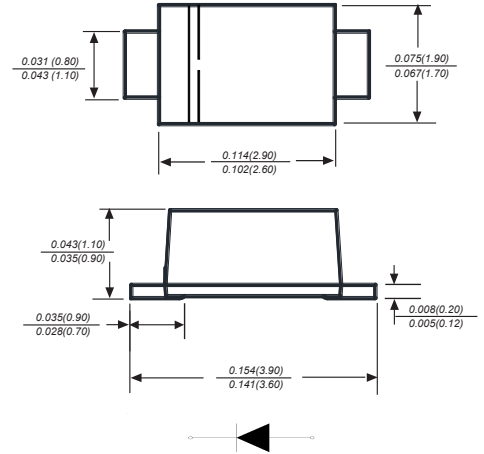

Dimensions in inches and (millimeters)

Mechanical Data

Case : JEDEC SOD-123FL molded plastic body
 Terminals : Solderable per MIL-STD-750, Method 2026
 Polarity : Color band denotes cathode end
 Mounting Position : Any
 Weight : 0.0007 ounce, 0.02 grams

Maximum Ratings And Electrical Characteristics

Ratings at 25°C ambient temperature unless otherwise specified.

Single phase half-wave 60Hz, resistive or inductive load, for capacitive load current derate by 20%.

Parameter	SYMBOLS	DSK32	DSK34	DSK35	DSK36	DSK38	DSK310	DSK315	DSK320	UNITS
Marking Code		K32	K34	K35	K36	K38	K310	K315	K320	
Maximum repetitive peak reverse voltage	V_{RRM}	20	40	50	60	80	100	150	200	V
Maximum RMS voltage	V_{RMS}	14	28	35	42	56	70	105	140	V
Maximum DC blocking voltage	V_{DC}	20	40	50	60	80	100	150	200	V
Maximum average forward rectified current at TL (see fig.1)	$I_{(AV)}$	3.0								A
Peak forward surge current 8.3ms single half sine-wave superimposed on rated load (JEDEC Method)	I_{FSM}	80								A
Maximum instantaneous forward voltage at 3.0A	V_F	0.55		0.70		0.85		0.95		V
Maximum DC reverse current $T_A=25^\circ\text{C}$ at rated DC blocking voltage $T_A=100^\circ\text{C}$	I_R	0.5				0.3				mA
Typical junction capacitance (NOTE 1)	C_J	250				160				pF
Typical thermal resistance (NOTE 2)	$R_{\theta JA}$	80.0								°C/W
Operating junction temperature range	T_J	-55 to +150								°C
Storage temperature range	T_{STG}	-55 to +150								°C

Note: 1. Measured at 1MHz and applied reverse voltage of 4.0V D.C.



DSK32 THRU DSK320

Reverse Voltage - 20 to 200 Volts Forward Current - 3.0 Ampere

Typical Characteristics

Fig.1 Forward Current Derating Curve

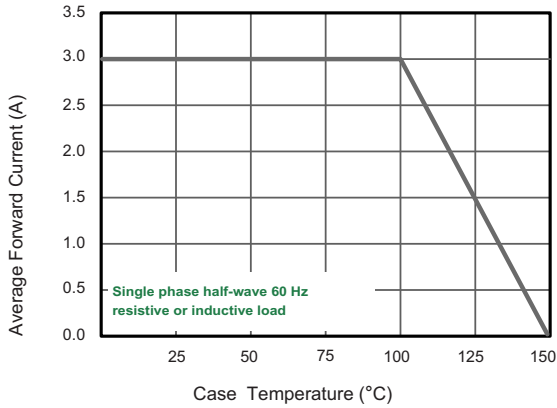

Fig.2 Typical Reverse Characteristics

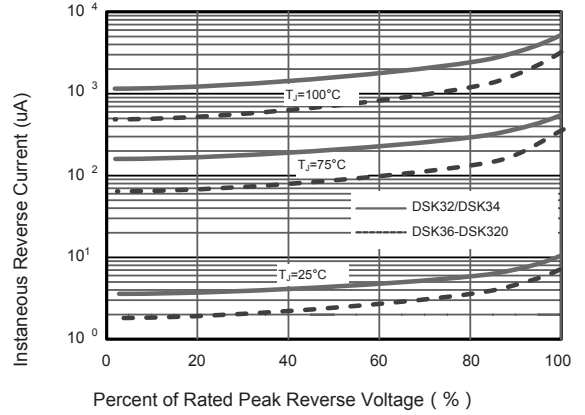

Fig.3 Typical Forward Characteristic

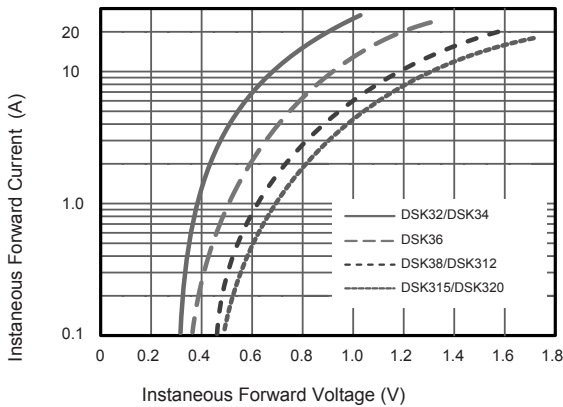

Fig.4 Typical Junction Capacitance

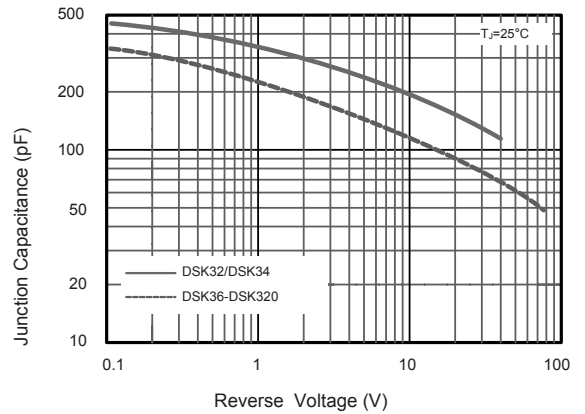

Fig.5 Maximum Non-Repetitive Peak Forward Surge Current

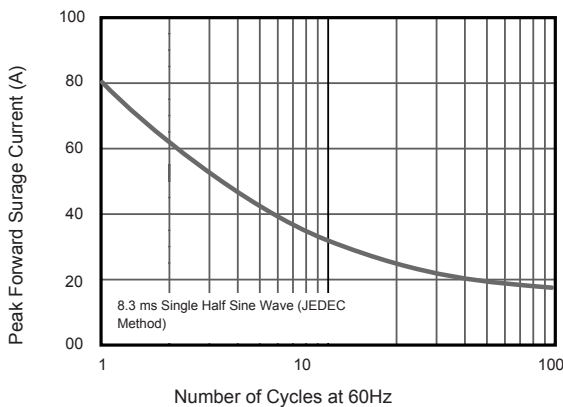
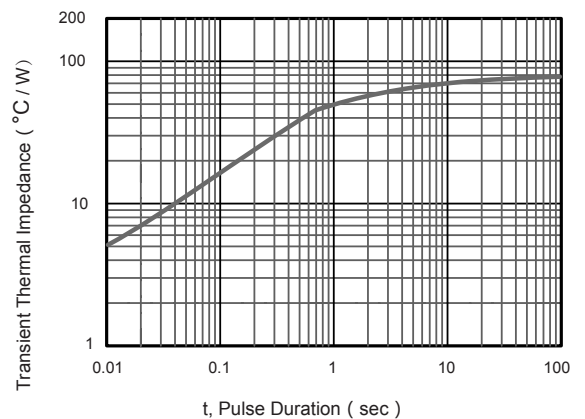

Fig.6 Typical Transient Thermal Impedance



The curve above is for reference only.



DSK32 THRU DSK320

Reverse Voltage - 20 to 200 Volts Forward Current -3.0 Ampere

Packing information

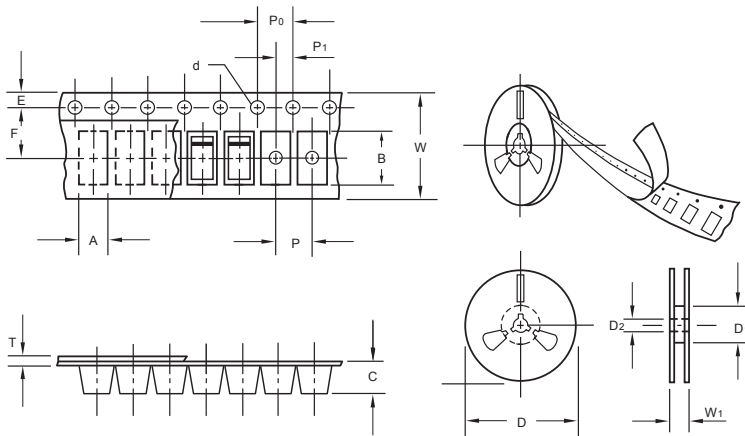

unit:mm

Item	Symbol	Tolerance	SOD-123FL
Carrier width	A	0.1	2.1
Carrier length	B	0.1	4.0
Carrier depth	C	0.1	1.60
Sprocket hole	d	0.05	1.55
7" Reel outside diameter	D	2.0	178.00
7" Reel inner diameter	D1	min	50.0
Feed hole diameter	D2	0.5	13.00
Sprocket hole position	E	0.1	1.75
Punch hole position	F	0.1	3.50
Punch hole pitch	P	0.1	4.00
Sprocket hole pitch	P0	0.1	4.00
Embossment center	P1	0.1	2.00
Overall tape thickness	T	0.1	0.25
Tape width	W	0.3	8.15
Reel width	W1	1.0	10.5

Note: Devices are packed in accordance with EIA standard RS-481-A and specifications listed above.

Reel packing

PACKAGE	REEL SIZE	REEL (pcs)	COMPONENT SPACING (m/m)	BOX (pcs)	INNER BOX (m/m)	REEL DIA, (m/m)	CARTON SIZE (m/m)	CARTON (pcs)	APPROX. GROSS WEIGHT (kg)
SOD-123FL	7"	3,000	4.0	45,000	210*208*203	178	430*430*235	180,000	9.0

Suggested Pad Layout

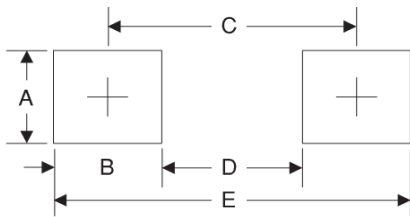

Symbol	Unit (mm)	Unit (inch)
A	1.2	0.047
B	1.2	0.047
C	3.2	0.126
D	2	0.079
E	4.4	0.173